

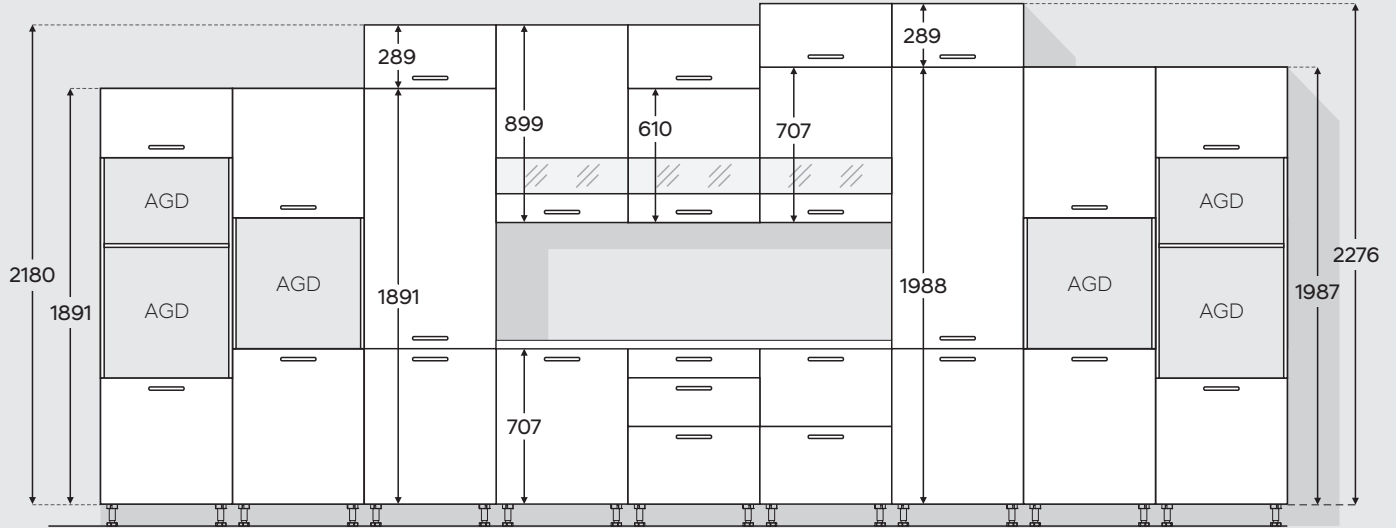

# KAMMONO

## TYPOSZEREG

wymiary technologiczne podane w mm



## WYSOKOŚĆ KUCHNI

propozycje zabudowy

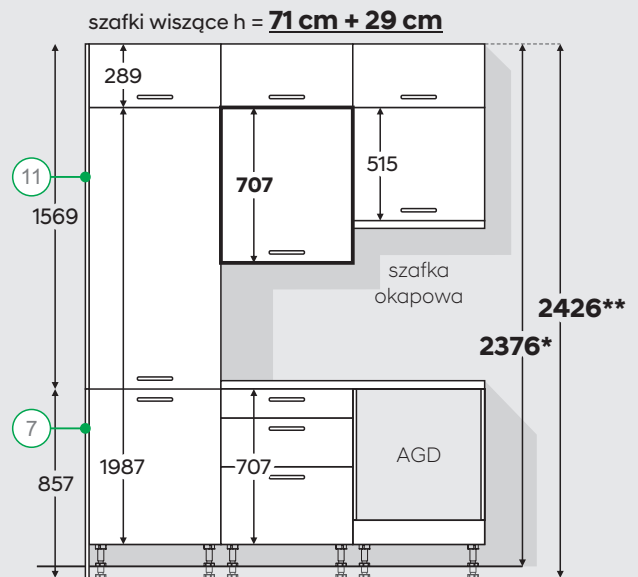
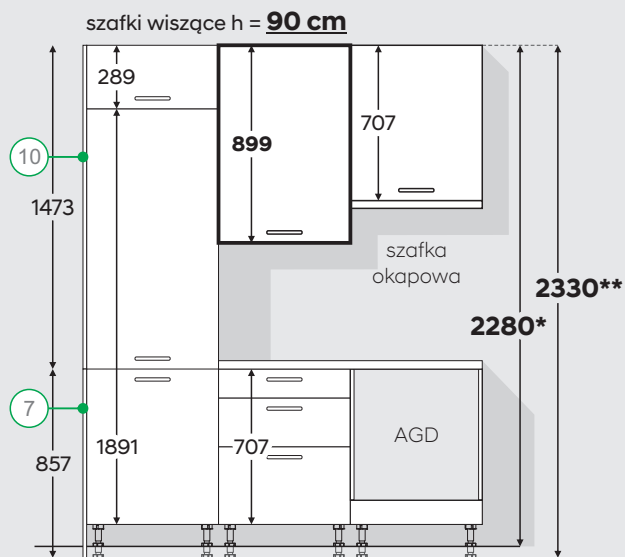
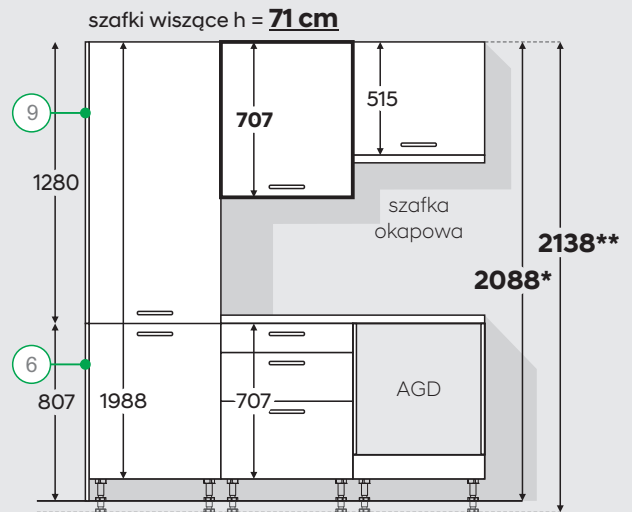
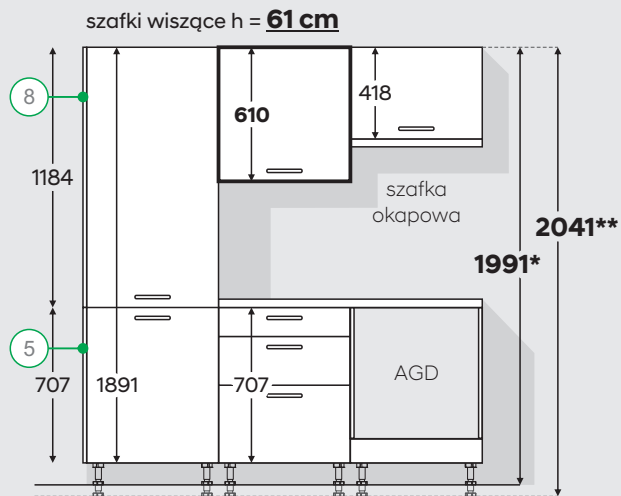









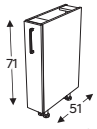
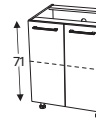
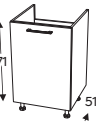
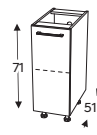

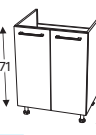

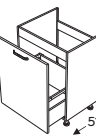
5 6 7 8 9 10 11 Wymiary boków nakładanych

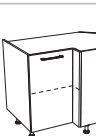
\* Wysokość z nóżkami wys. 10 cm. \*\* Wysokość z nóżkami wys. 15 cm.

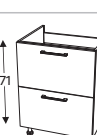
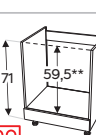
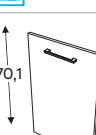
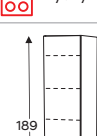
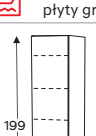
# Szafki dolne - MONO - wysokość nógek 10 lub 15 cm

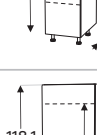
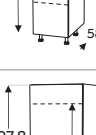

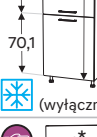
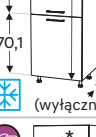
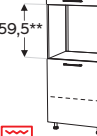
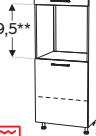
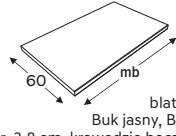



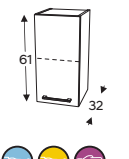
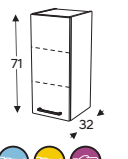
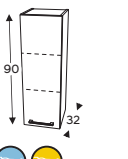
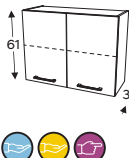
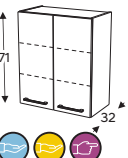
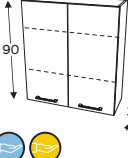
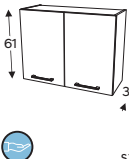
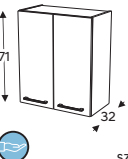
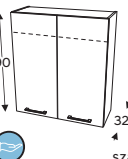
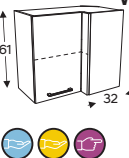

P2, K2, P4: fronty nowoczesne.  
F: fronty frezowane F4, F5, F7.

MODEL	↔	P2, K2	P4	F	MODEL	↔	P2, K2	P4	F	MODEL	↔	P2, K2	P4	F
 szafka z koszem cargo 15, 20 cm - uchwyt pionowo 30 cm - uchwyt poziomo	15 20 30	326,- 369,- 405,-	337,- 382,- 426,-	341,- 390,- 442,-	 D...	60 80	249,- 286,-	292,- 341,-	325,- 389,-	 DZ... .1	45 50 60	178,- 185,- 198,-	207,- 220,- 240,-	238,- 251,- 281,-
 D... .1 PRAWA/Lewa	30 35 40 45 50 60	164,- 172,- 179,- 191,- 198,- 218,-	184,- 196,- 207,- 221,- 234,- 259,-	202,- 217,- 232,- 248,- 265,- 298,-	 DRP90 szafka narożna bez cichego domykania uniwersalna	90 x 90	431,-	474,-	512,-	 DZ... szafka zlewozmywakowa PRAWA/Lewa	60 70 80 90	227,- 244,- 251,- 267,-	267,- 292,- 306,- 328,-	300,- 334,- 354,- 383,-
 DS.../3 szuflady z hamulcem	30 35,40 45 50	416,- 429,- 444,- 459,-	440,- 454,- 474,- 491,-	451,- 465,- 485,- 508,-	 DRP90x70 szafka narożna bez cichego domykania PRAWA/Lewa	90 x 70	405,-	436,-	463,-	 DZCSS60 szafka cargo zlewozmywakowa przygotowana do montażu sortownika na odpady 3x14l	60	386,-	427,-	465,-
 DSS.../3 szuflady o zwiększonej wytrzymałości na obciążenie i hamulcem	40 45 50 55,60 65,70 75,80 85,90	669,- 687,- 707,- 728,- 774,- 787,- 814,-	695,- 717,- 738,- 756,- 789,- 822,- 841,- 872,-	708,- 728,- 756,- 789,- 850,- 872,- 900,-	 DRP100x70 szafka narożna bez cichego domykania PRAWA/Lewa	100 x 70	444,-	483,-	508,-	 DRZ100x70 szafka narożna bez cichego domykania PRAWA/Lewa	100 x 70	404,-	444,-	474,-
 DSS.../2PŁ szafka do zabudowy płyty grzewczej szuflady o zwiększonej wytrzymałości na obciążenie i hamulcem	60 70 80 90	569,- 608,- 624,- 655,-	611,- 658,- 679,- 713,-	642,- 695,- 720,- 756,-	 DP... szafka do zabudowy płyty grzewczej i piekarnika	45 60	190,- 207,-	194,- 213,-	194,- 213,-	 FZMYW... front zmywarki zalecany do szafek z nóżkami h=15 cm (min. wysokość nógek to 11 cm)	45 60	63,- 73,-	95,- 118,-	105,- 135,-
 SD...D2 PRAWA/Lewa	40 50 60	463,- 519,- 567,-	538,- 613,- 680,-	618,- 712,- 798,-	 SD...D2/71 PRAWA/Lewa	40 50 60	502,- 564,- 618,-	582,- 663,- 737,-	666,- 770,- 863,-	 WO.../29N szafka do montażu nad słupkami	40 45 50 60 70 80	146,- 153,- 157,- 172,- 188,- 203,-	157,- 167,- 172,- 188,- 208,- 226,-	161,- 176,- 181,- 197,- 226,- 243,-
 SL60 szafka do zabudowy lodówki PRAWA/Lewa (wyłącznie zawiasy ślizgowe)	60	491,-	607,-	718,-	 SL60/71 szafka do zabudowy lodówki PRAWA/Lewa (wyłącznie zawiasy ślizgowe)	60	518,-	643,-	762,-	 SNO60/29N nadstawka do montażu nad słupkami AGD z większą przestrzenią wentylacyjną	60	168,-	184,-	193,-
 SDP60 szafka do zabudowy piekarnika PRAWA/Lewa	60	502,-	578,-	662,-	 SDP60/71 szafka do zabudowy piekarnika PRAWA/Lewa	60	525,-	606,-	702,-	<p><b>Ceny szafek obejmują:</b> korpusy z półkami, fronty, zawiasy puszkowe, szuflady, podnośniki gazowe, uchwyty oraz nóżki.</p> <p><b>Szafki sprzedawane w paczkach, gotowe do samodzielnego montażu zgodnie z załączoną instrukcją.</b></p>				
 SPM60 szafka do zabudowy mikrofalówki oraz piekarnika PRAWA/Lewa	60	589,-	641,-	684,-	 SPM60/71 szafka do zabudowy mikrofalówki oraz piekarnika PRAWA/Lewa	60	639,-	700,-	752,-					
 BLAT R3 blat Dąb złoty, Dąb arlington, Buk jasny, Beton jasnoszary, Czarny E gr. 3,8 cm, krawędzie boczne ABS, L max. = 400 cm											↔	CENA		
											100	160,-		
											<p>Wysyłka blatów spedycją: L max.=240 cm bez dopłaty, L max.=350 cm dopłata 138,-</p>			

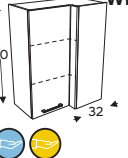
\* Opcja otwierania przez dotyk (PTO) tylko w drzwiach nad sprzętem AGD. \*\* Zewnętrzny wymiar sprzętu AGD.

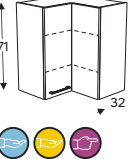
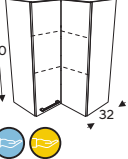
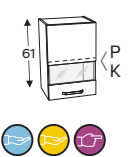
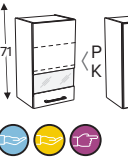
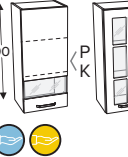
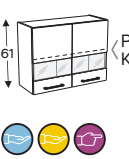
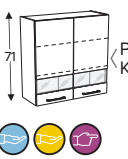
# Szafki wiszące - MONO - głębokość z frontem 32 i 58 cm

P2, K2, P4: szkło mleczne.  
F: szkło bezbarwne lub mleczne.

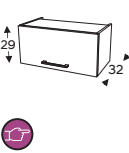
MODEL	↔	P2, K2	P4	F	MODEL	↔	P2, K2	P4	F	MODEL	↔	P2, K2	P4	F
 W... /61 PRAWA/Lewa	15 <sup>***</sup> 20 <sup>****</sup> 30 35 40 45 50 55,60	97,- 105,- 118,- 127,- 134,- 138,- 145,- 167,-	106,- 116,- 136,- 147,- 156,- 164,- 173,- 203,-	109,- 119,- 150,- 160,- 173,- 186,- 194,- 220,-	 W... /71 PRAWA/Lewa	15 <sup>***</sup> 20 <sup>****</sup> 30 35 40 45 50 55,60	120,- 126,- 146,- 155,- 163,- 174,- 189,- 207,-	135,- 139,- 166,- 179,- 191,- 206,- 220,- 246,-	141,- 147,- 183,- 201,- 214,- 231,- 252,- 283,-	 W... /90 PRAWA/Lewa	15 <sup>***</sup> 20 <sup>****</sup> 30 35 40 45 50 55,60	139,- 144,- 167,- 176,- 186,- 197,- 214,- 234,-	157,- 161,- 193,- 207,- 221,- 237,- 255,- 285,-	167,- 173,- 217,- 237,- 254,- 274,- 299,- 337,-
 W.../61	60 70 80	199,- 207,- 219,-	220,- 240,- 255,-	244,- 273,- 291,-	 W.../71	60 70 80	232,- 253,- 266,-	275,- 300,- 322,-	306,- 346,- 368,-	 W.../90	60 70 80	259,- 281,- 297,-	314,- 345,- 370,-	360,- 406,- 434,-
 WS.../61 szafka suszarkowa	60 80	285,- 324,-	320,- 369,-	343,- 404,-	 WS.../71 szafka suszarkowa	60 80	323,- 366,-	364,- 419,-	393,- 464,-	 WS.../90 szafka suszarkowa	60 80	347,- 393,-	400,- 465,-	446,- 531,-
 WRP70x40/61 szafka narożna bez cichego domykania PRAWA/lewa	70 X 40	243,-	269,-	286,-	 WRP70x40/71 szafka narożna bez cichego domykania PRAWA/lewa	70 X 40	311,-	341,-	362,-	 WRP70x40/90 szafka narożna bez cichego domykania PRAWA/lewa	70 X 40	333,-	374,-	406,-
 WRP60/61 szafka narożna bez cichego domykania uniwersalna	60 X 60	238,-	269,-	291,-	 WRP60/71 szafka narożna bez cichego domykania uniwersalna	60 X 60	314,-	349,-	381,-	 WRP60/90 szafka narożna bez cichego domykania uniwersalna	60 X 60	336,-	385,-	428,-
 WW... /61 witryna PRAWA/Lewa	40 45 50 60	165,- 176,- 183,- 199,-	182,- 195,- 203,- 224,-	193,- 207,- 221,- 249,-	 WW... /71 witryna PRAWA/Lewa	40 45 50 60	202,- 213,- 231,- 256,-	223,- 235,- 252,- 282,-	244,- 262,- 289,- 325,-	 WW... /90 witryna PRAWA/Lewa	40 45 50 60	225,- 237,- 255,- 282,-	253,- 268,- 286,- 321,-	289,- 312,- 341,- 387,-
 WW80/61 witryna	80	273,-	306,-	334,-	 WW80/71 witryna	80	338,-	378,-	429,-	 WW80/90 witryna	80	368,-	424,-	505,-
 WO60/42P1 WO60/42P1B WO60/42P1C cena z okapem P1, P1B lub P1C dedykowana do montażu z szafkami wys. 61 cm	60	523,-	545,-	561,-	 WO60/51P1 WO60/51P1B WO60/51P1C cena z okapem P1, P1B lub P1C dedykowana do montażu z szafkami wys. 71 cm PRAWA/Lewa	60	536,-	566,-	594,-	 W60.1/P1 W60.1/P1B W60.1/P1C cena z okapem P1, P1B lub P1C dedykowana do montażu z szafkami wys. 90 cm PRAWA/Lewa	60	578,-	621,-	660,-
 WO.../29	40 45 50 60 70 80 90	121,- 125,- 129,- 138,- 146,- 156,- 163,-	132,- 138,- 144,- 154,- 166,- 177,- 191,-	139,- 146,- 153,- 166,- 181,- 194,- 207,-										



## Opcje otwierania zamiast uchwytu.

Dostępne w szafkach z frontami nowoczesnymi P2 i P4.

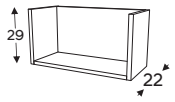
PWF...	↔	CENA
	50	99,-
	60	103,-
	70	108,-
	80	111,-
	90	119,-

półka wykonana z płyty w kolorze: dąb arlington, dąb złoty, buk jasny, beton jasnoszary

\*\*\* Szafka bez uchwytu, dostępna tylko ze splotonym wiercem (WU).

\*\*\*\* Szafka dopasowana wyłącznie do okapu teleskopowego FRANKE P1, P1B, P1C.

# ELEMENTY DODATKOWE

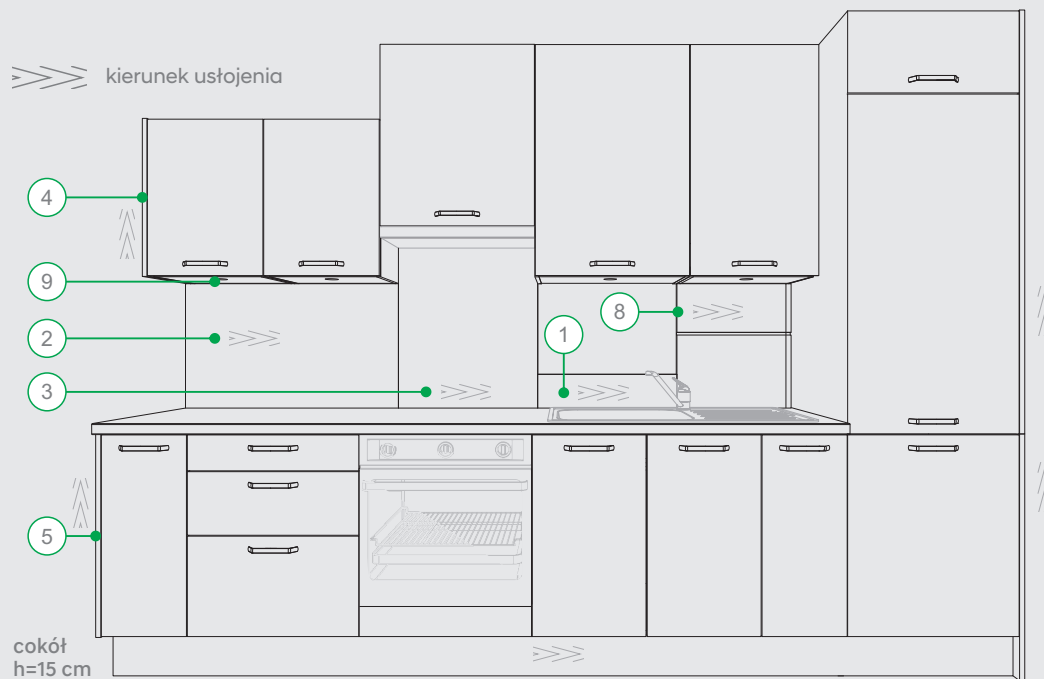

Półka ścienna PZ..., gr. 15 cm

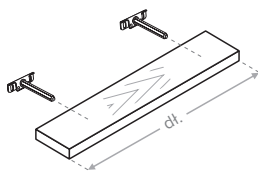

45 cm	83,-	90 cm	102,-
50 cm	85,-	100 cm	106,-
55 cm	88,-	110 cm	110,-
60 cm	89,-	120 cm	128,-
70 cm	94,-	130 cm	133,-
80 cm	98,-	140 cm	137,-

grupa P2\*  
gr. 3,6 cm

Panele przyściennne cena za 1 mb

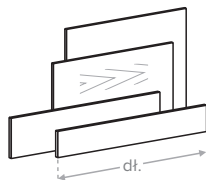

h=11 cm	20,-
① h=14,5 cm	22,-
② h=53,5 cm	66,-
③ h=72,8 cm	89,-

grupa P2\*  
gr. 1,8 cm, długość do 240 cm,

Bok nakładany szafki wiszącej

	P2*	P4*	F6*
④ 61 cm	30,-	53,-	56,-
71 cm	35,-	61,-	67,-
90 cm	41,-	72,-	83,-

P2\* i P4\* gr. 32 cm, F6\* gr. 31,4 cm

Bok nakładany szafki dolnej

	P2*	P4*	F6*
⑤ 71 cm	54,-	99,-	117,-
⑥ 81 cm	62,-	110,-	134,-
⑦ 86 cm	64,-	117,-	142,-
⑧ 118 cm	79,-	155,-	195,-
⑨ 128 cm	86,-	168,-	212,-
⑩ 147 cm	98,-	190,-	243,-
⑪ 157 cm	105,-	203,-	260,-

P2\* i P4\* gr. 58,0 cm, F6\* gr. 57,4 cm

\*\* Wieniec oświetleniowy przeznaczony do szafek gr. 32 cm z 1 otworem

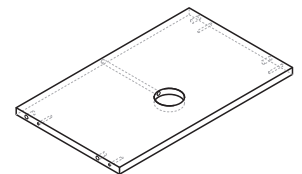

⑨ 30 ÷ 60 cm	57,-
70 ÷ 90 cm	71,-

kolor płyty korpusowej, gr. 1,6 cm  
wieniec wymienny do szafek szer.:  
30, 35, 40, 45, 50, 60, 70, 80, 90 cm,

Panel przyścienny z profilem ZOBAL, h=53,5 cm

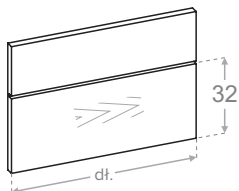

⑧ 1 mb 91,-

grupa P2\*  
gr. 1,8 cm, max. długość: 275 cm

Formatki okleinowane cena za 1 m<sup>2</sup>

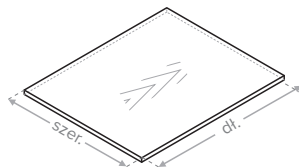

grupa	kolor płyty	gr. 1,6 cm	gr. 1,8 cm	gr. 3,6 cm
I	biel alpejska	138,-	-	-
	P2*	-	138,-	292,-
II	P4*	-	246,-	-
III	F4, F5, F7 lub F6*	288,-	-	-

min. wymiar: 15 x 15 cm lub 6,5 x 25 cm,  
max. wymiar: I - 275 x 200 cm, II - 200 x 120 cm, III - 200 x 100 cm

\*\* Wieniec oświetleniowy przeznaczone do szafek narożnych gr. 32 cm z 1 otworem

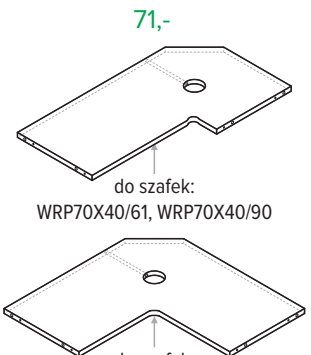

71,-  
do szafek:  
WRP70X40/61, WRP70X40/90

do szafek:  
WRP60/61, WRP60/90

kolor płyty korpusowej, gr. 1,6 cm

\* P2 - gr. 1,8 cm: Pinia biała, Sosna andersen, Buk jasny, Dąb arlington, Dąb złoty, Dąb szary, Beton jasnoszary.

P4 - gr. 1,8 cm: Biały POŁYSK, Szary POŁYSK, Biały MAT, Szary MAT, Czarny MAT.

F6 - gr. 1,6 cm, frez obwiedniowy, pasujące do frontów z grupy F4, F5 lub F7 w kolorach: Biały, Sosna A, Szary, Kaszmir, Dąb arlington F, Granat, Bazalt.

\*\* W sprzedaży wyłącznie z oświetleniem: LED OL14, ROTONDO lub ROUND.

Niniejszy folder nie stanowi oferty w rozumieniu prawa i jest publikowany jedynie w celach informacyjnych.

Ceny produktów mogą ulec zmianie. Aktualne ceny dostępne są w serwisie B2B lub w biurze sprzedaży mebli KAM, w dniu składania zamówienia.

Producent zastrzega sobie prawo do dokonania w dowolnej chwili zmian w katalogu bez podania przyczyny.